

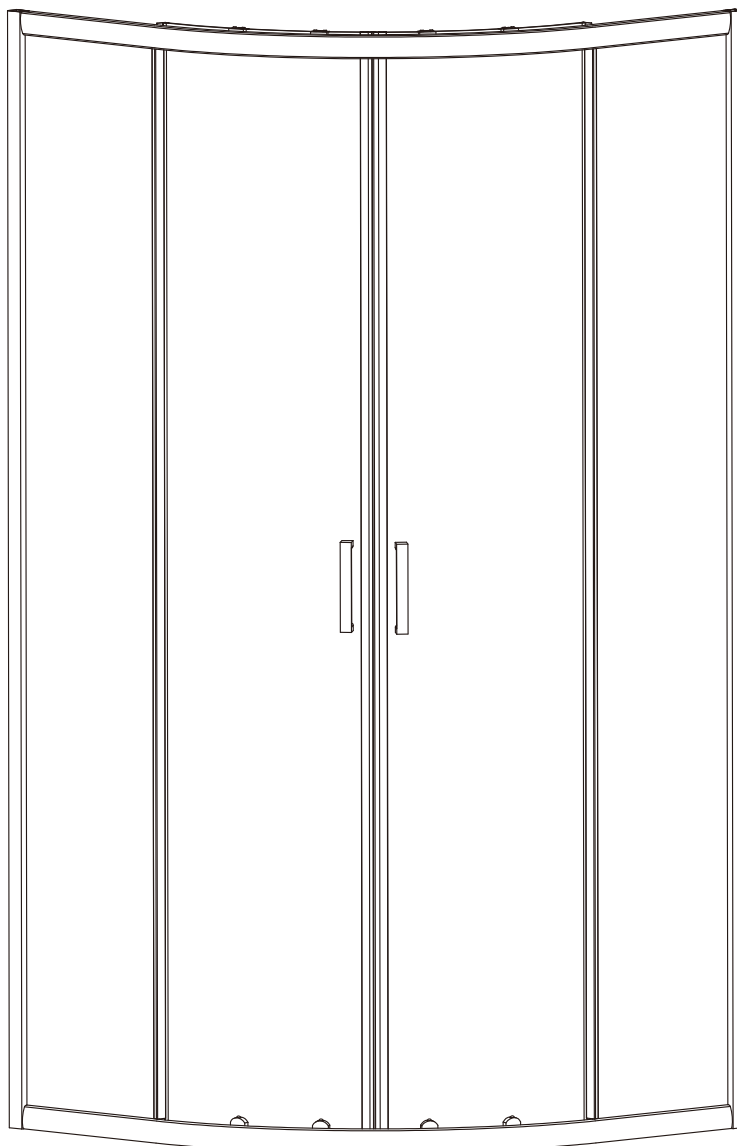

Душевой угол

RV-202/202B



Инструкция по установке

Пожалуйста, прочитайте инструкцию перед установкой

 Перед установкой поддон для душа должен быть выставлен по уровню и полностью герметичным к плитке.

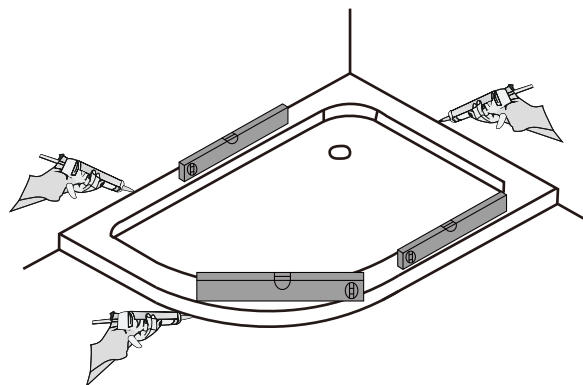

Необходимые инструменты и оборудование



Карандаш



Сверло

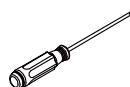

Отвертка

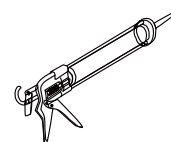

Силикон

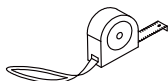

Рулетка

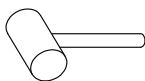

Молоток



Уровень



Дрель

Общий вид душевого угла

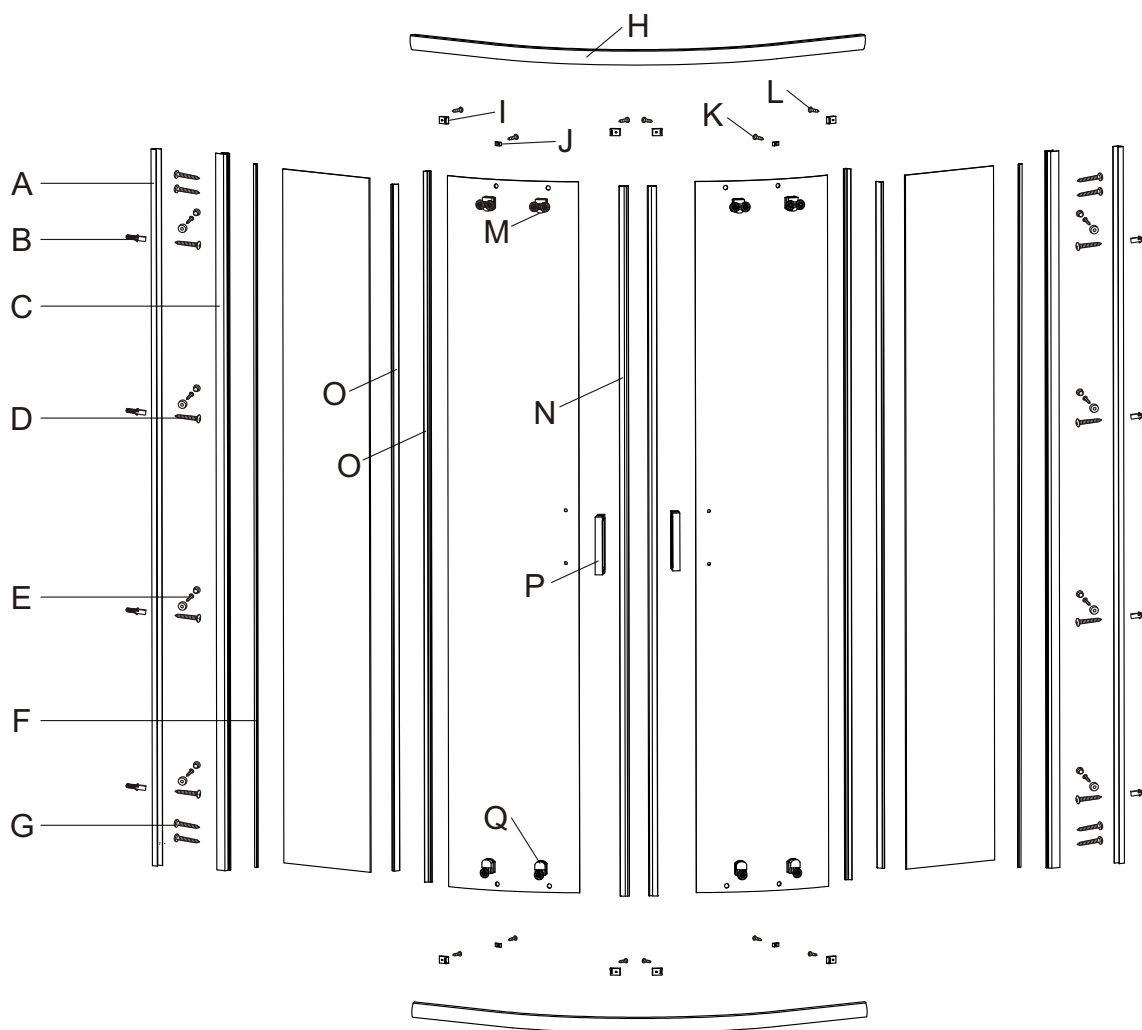

Комплектующие

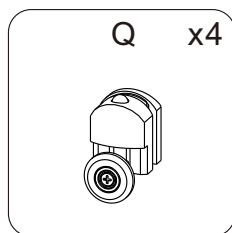
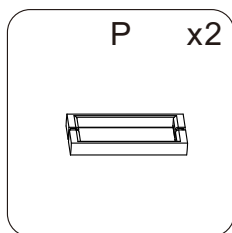
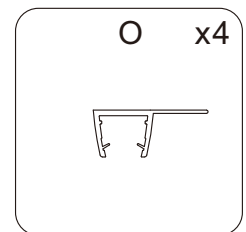
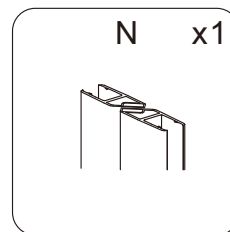
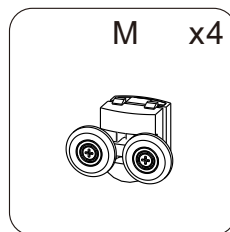
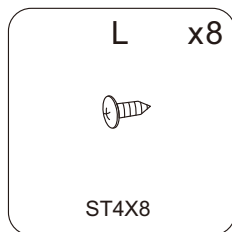
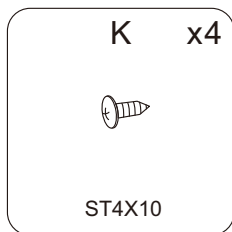
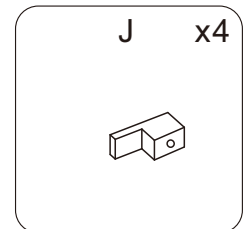
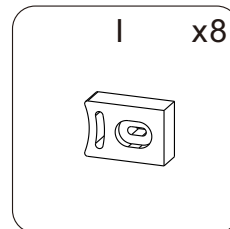
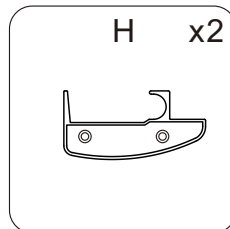
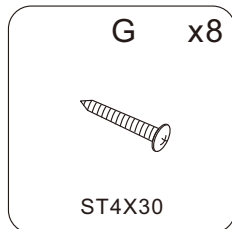
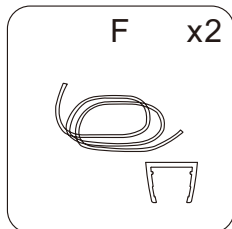
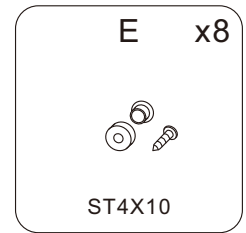
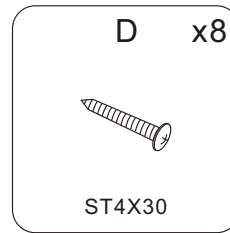
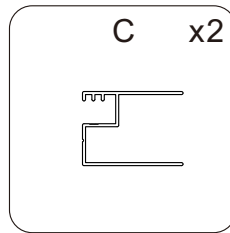
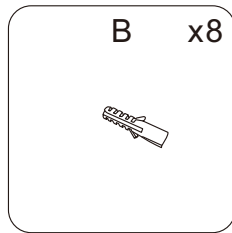
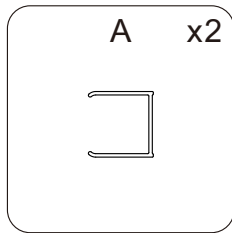

шаг 1

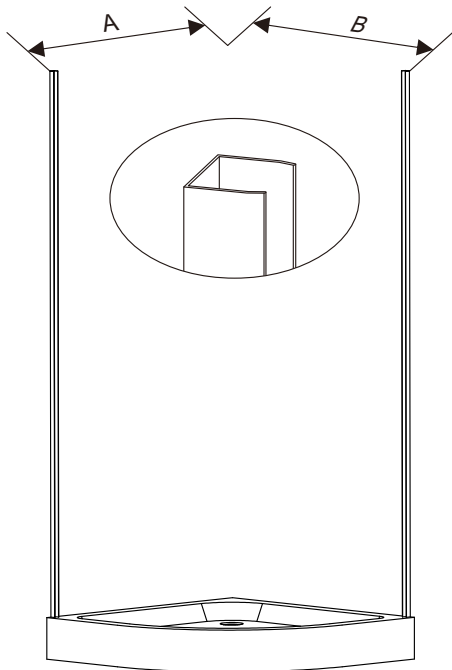

Артикул	Монтажный размер, мм
RV202/202B-80-01-C6	780-790X780-790
RV202/202B-90-01-C6	880-890X880-890

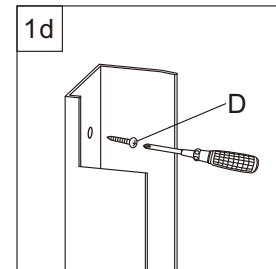
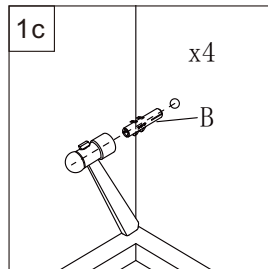
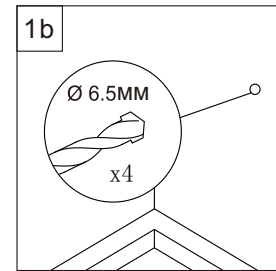
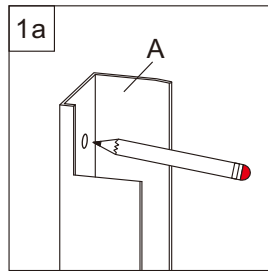

шаг 2

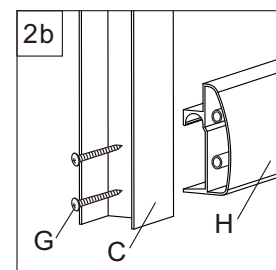
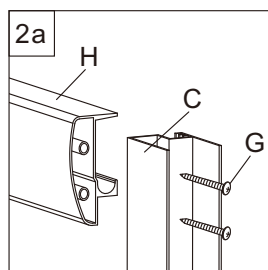
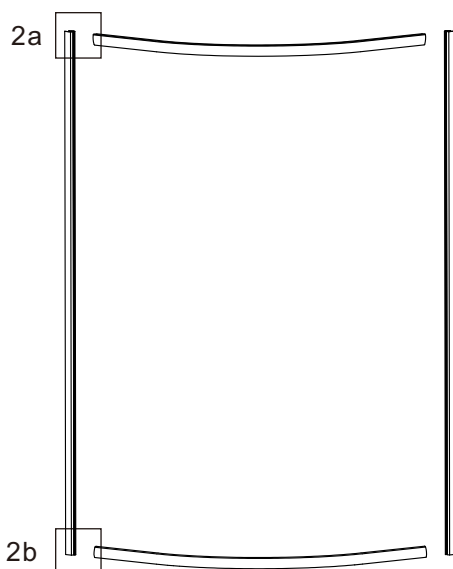

шаг 3

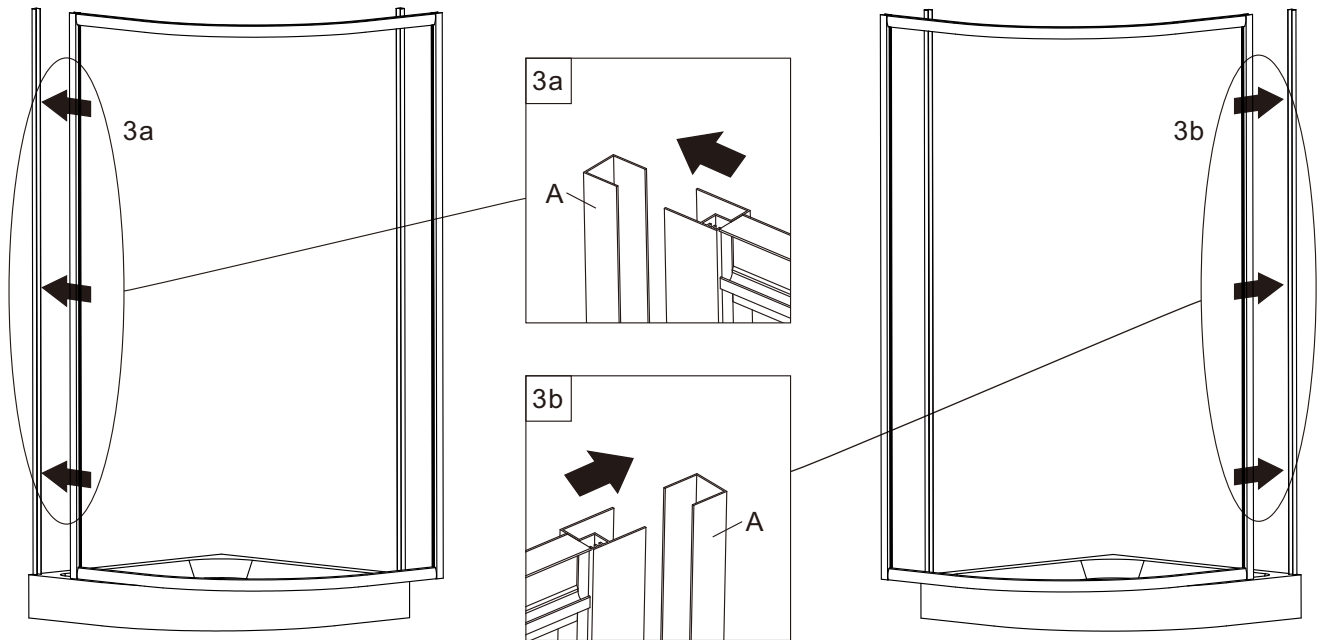

шаг 4

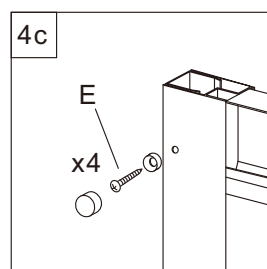
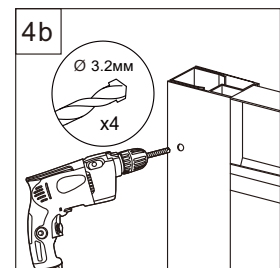
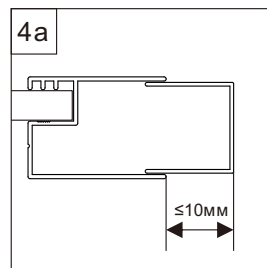
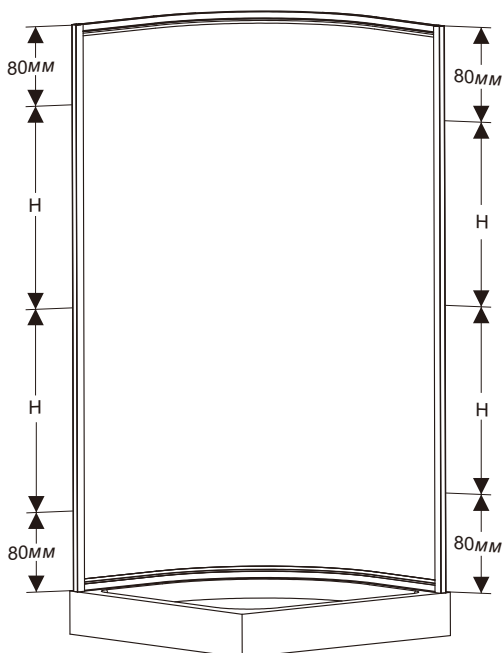

шаг 5

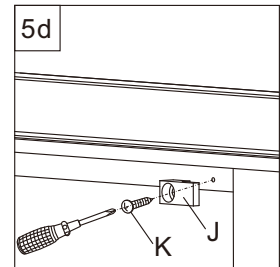
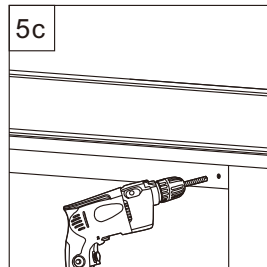
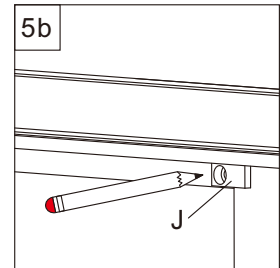
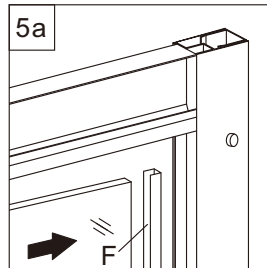
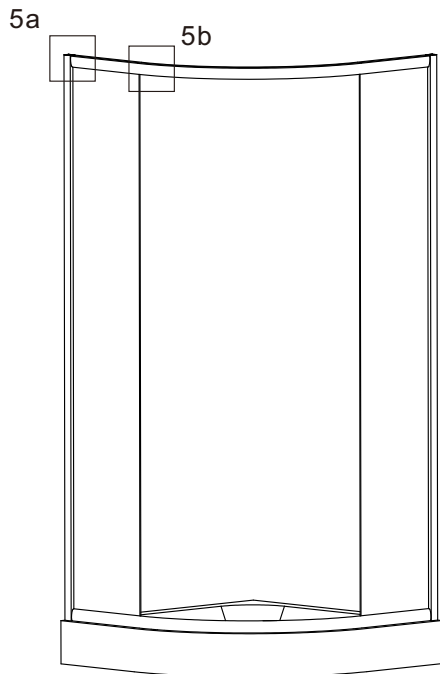

шаг 6

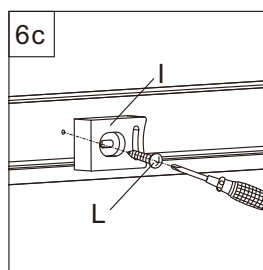
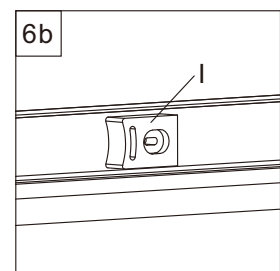
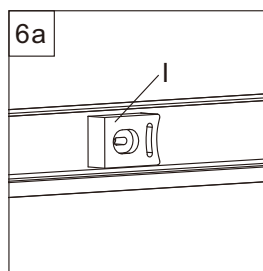
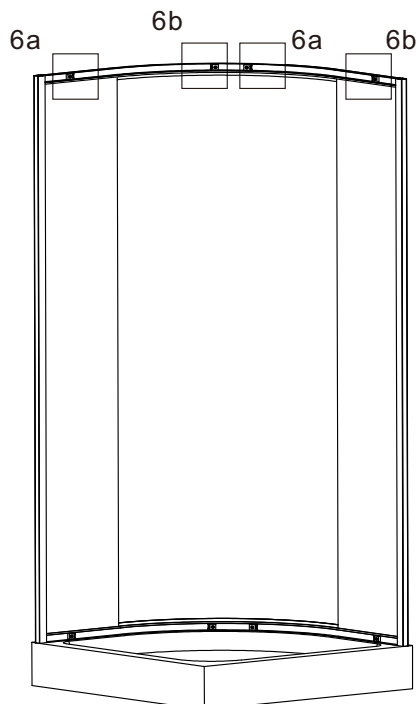

шаг 7

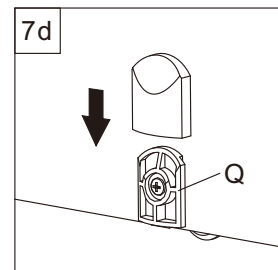
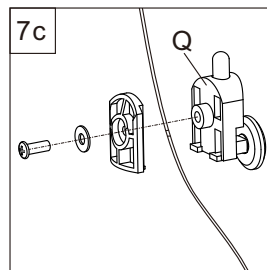
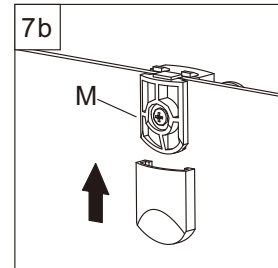
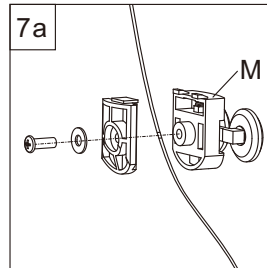
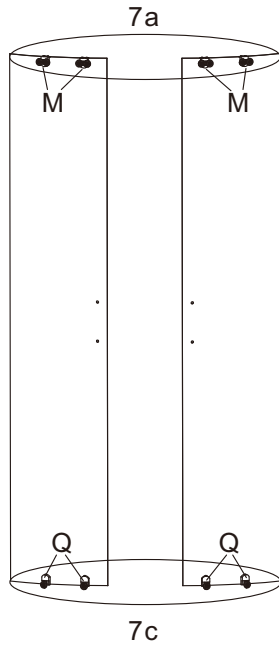

шаг 8

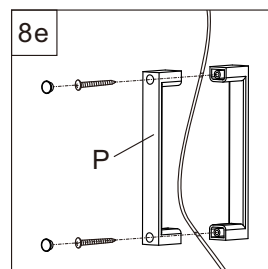
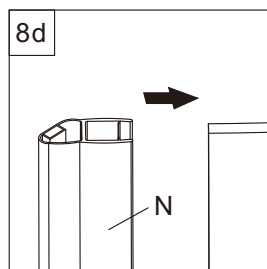
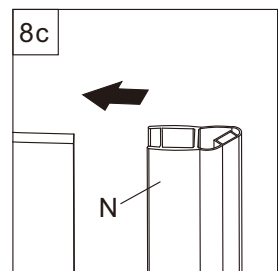
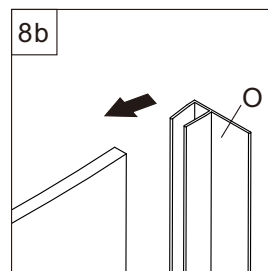
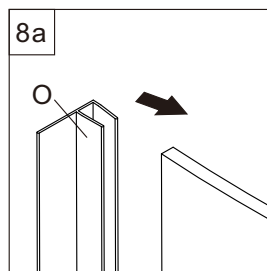
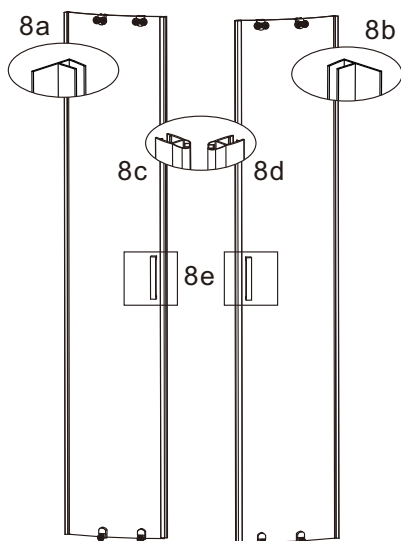

шаг 9

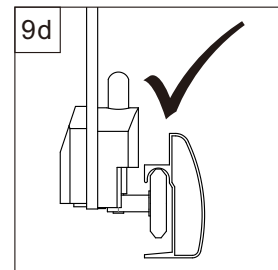
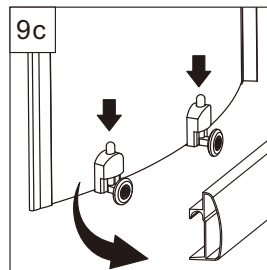
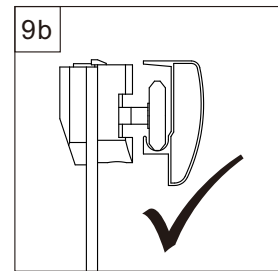
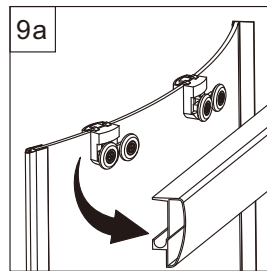
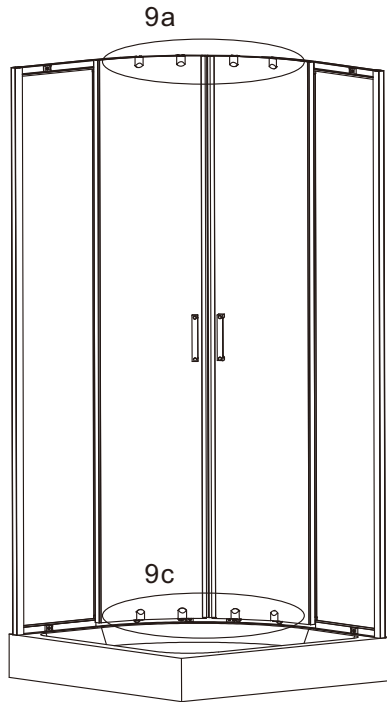

шаг 10

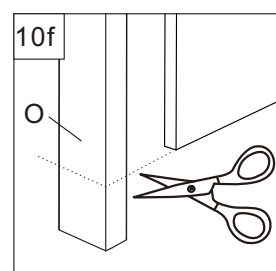
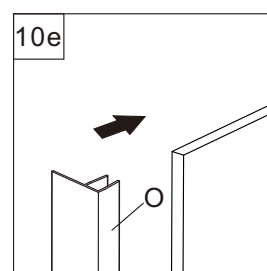
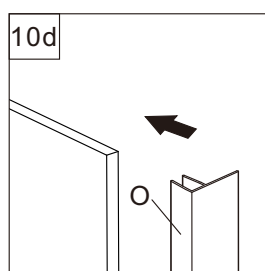
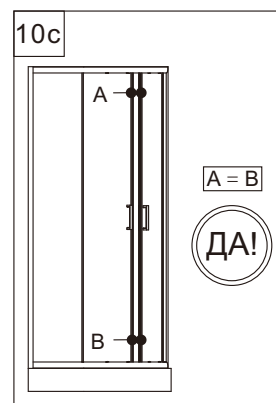
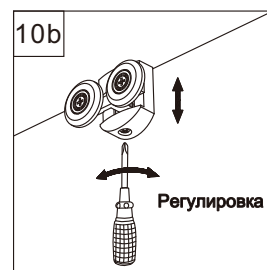
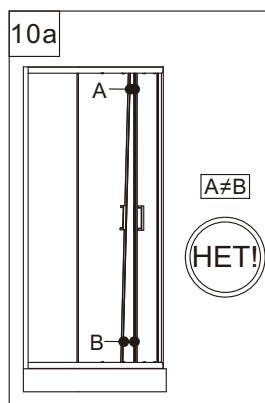
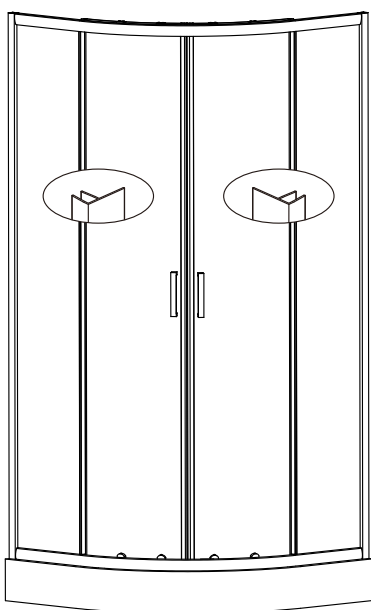

шаг 11

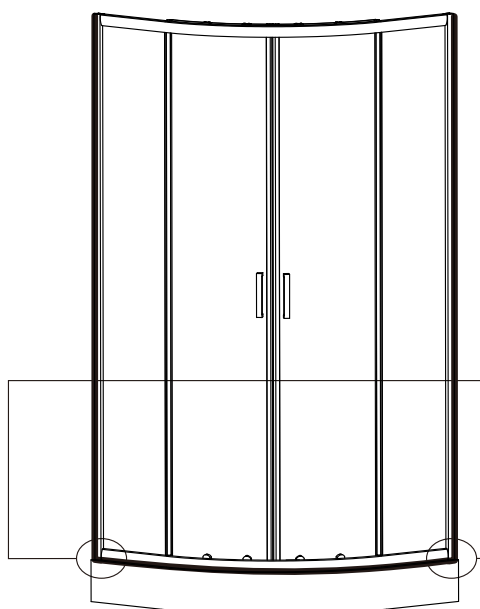

Примечание: не используйте
душевую в течение 24 часов после
нанесения силиконового клея

