

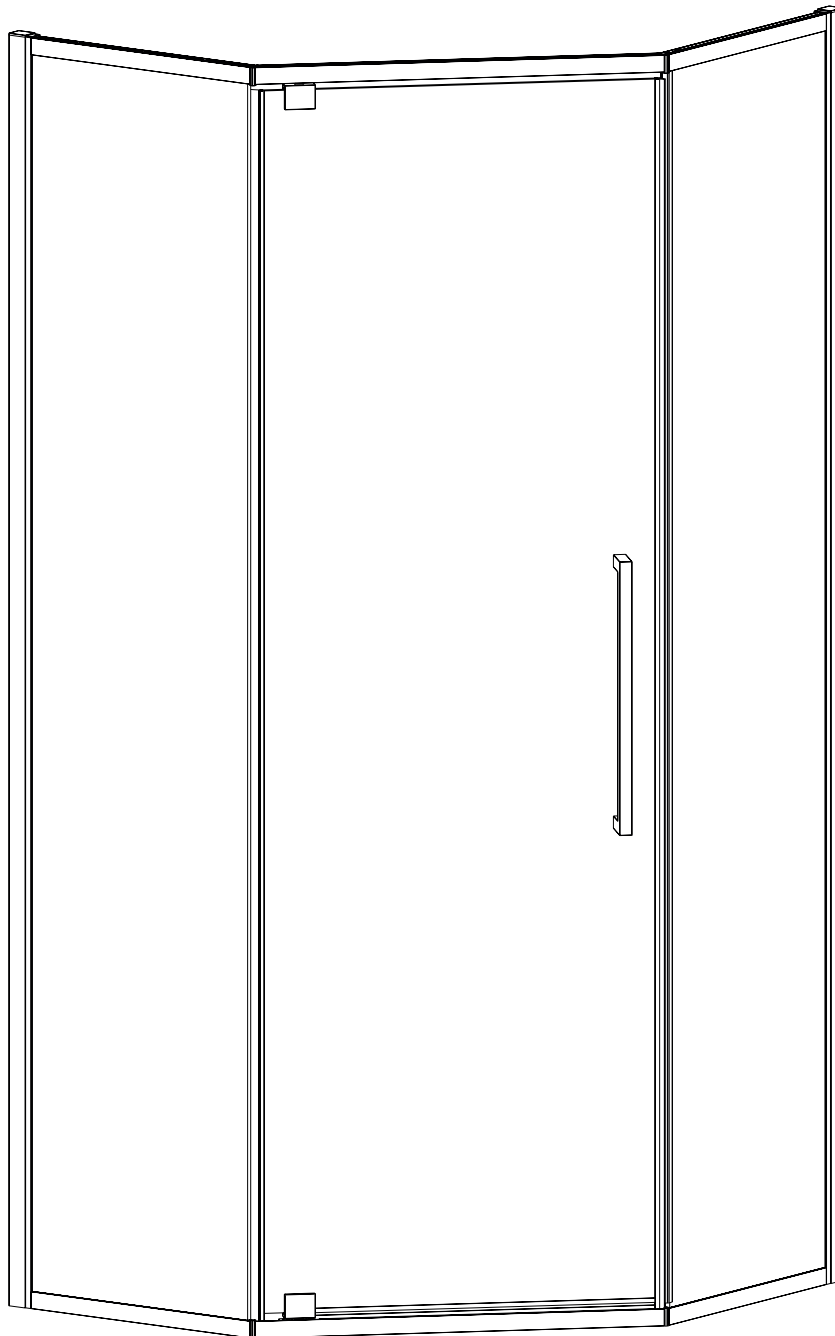

Душевой угол

RV-35/35B



Инструкция по установке

Пожалуйста, прочитайте инструкцию перед установкой

 Перед установкой поддон для душа должен быть выставлен по уровню и полностью герметичным к плитке.

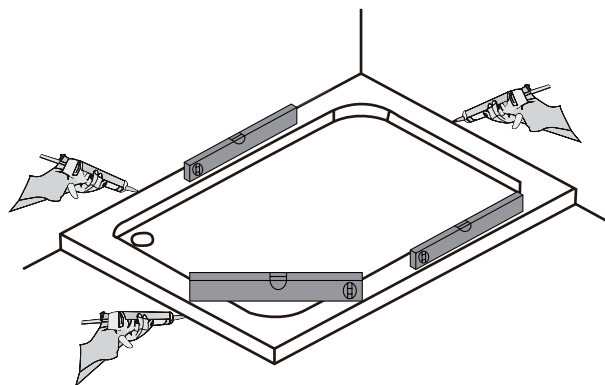

Необходимые инструменты и оборудование



Карандаш

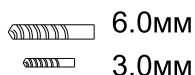

Сверло



Отвертка

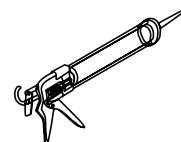

Силикон

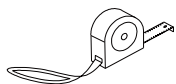

Рулетка

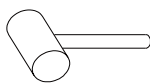

Молоток



Уровень

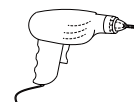

Дрель

Данная модель с универсальной установкой открывания двери

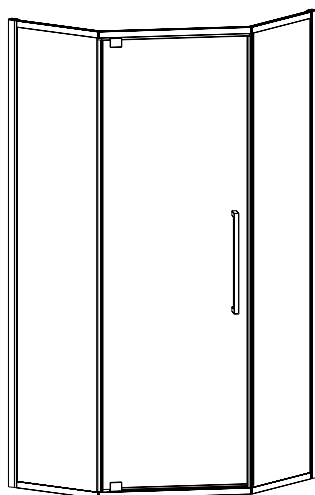

Левая ориентация

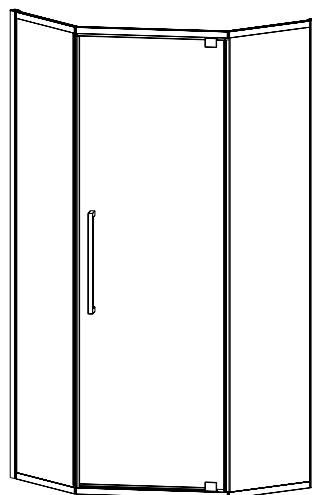

Правая ориентация

Общий вид душевого угла

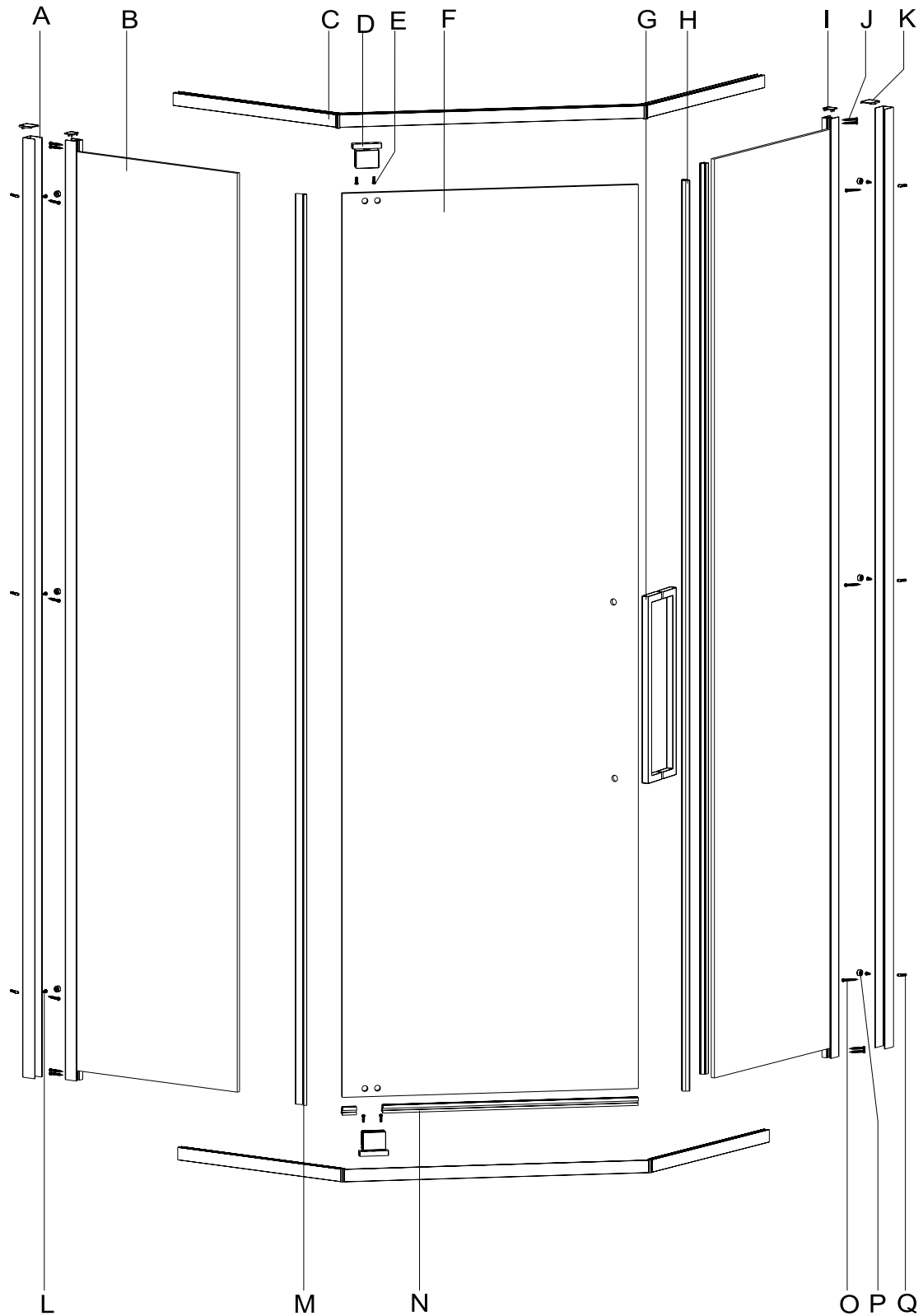

Перечень деталей

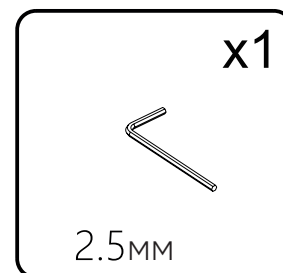
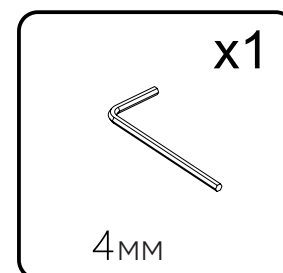
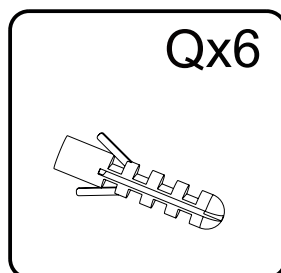
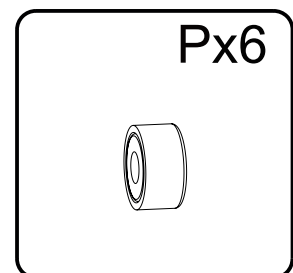
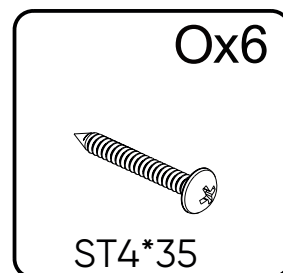
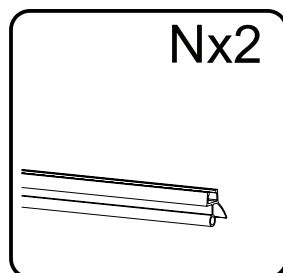
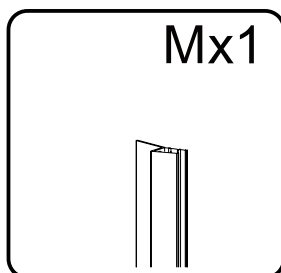
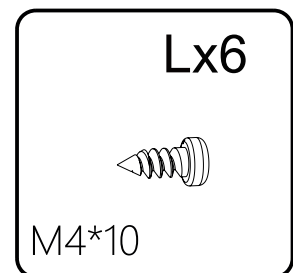
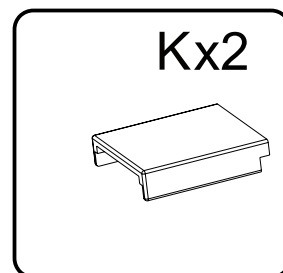
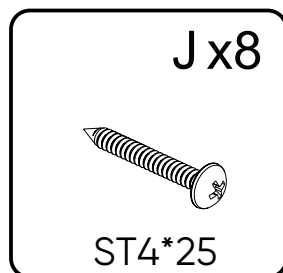
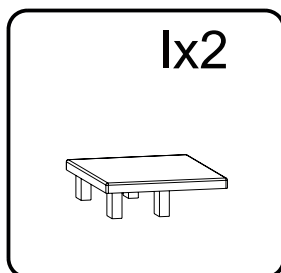
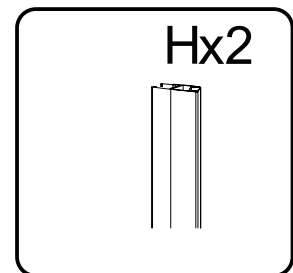
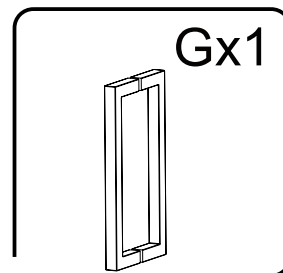
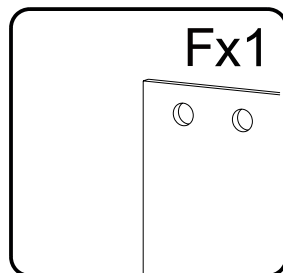
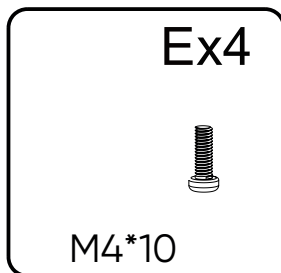
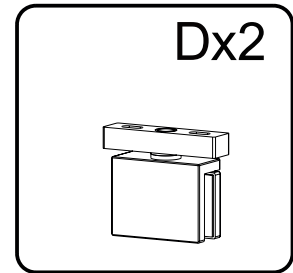
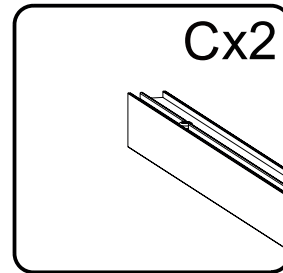
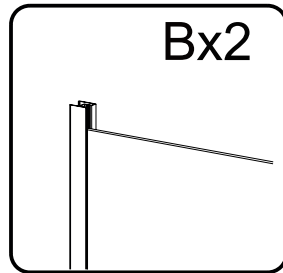
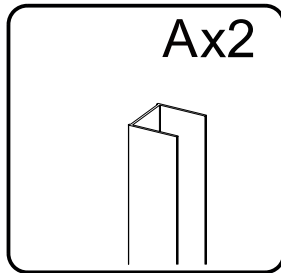

шаг 1

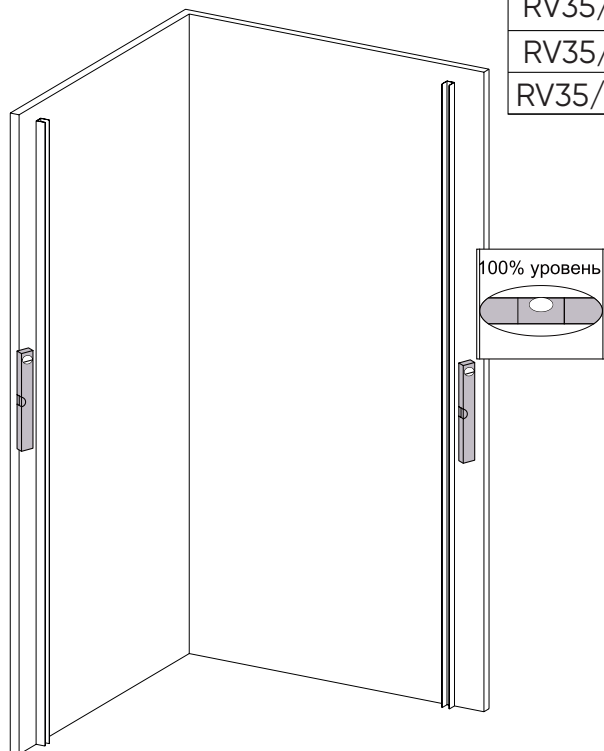

Артикул	Монтажный размер, мм
RV35/35B-80-01-C7	785-800x785-800
RV35/35B-90-01-C7	785-800x785-800
RV35/35B-100-01-C7	785-800x785-800

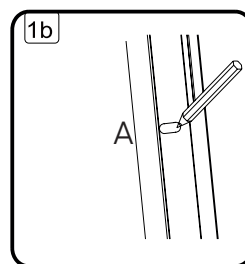
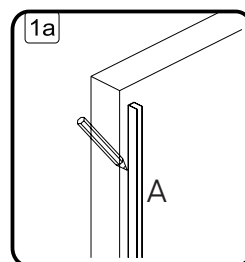

шаг 2

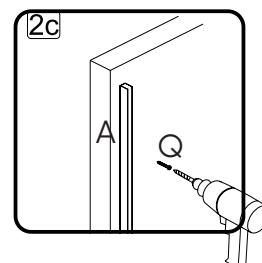
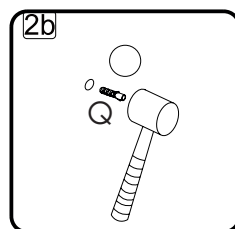
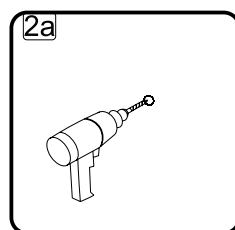
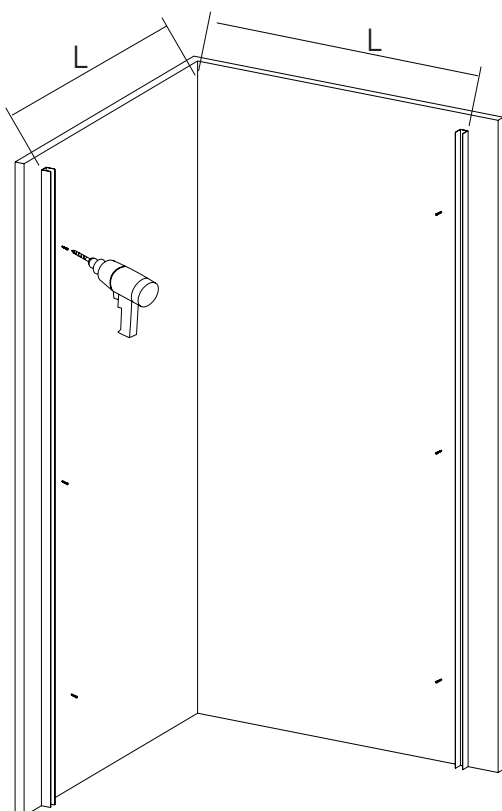

шаг 3

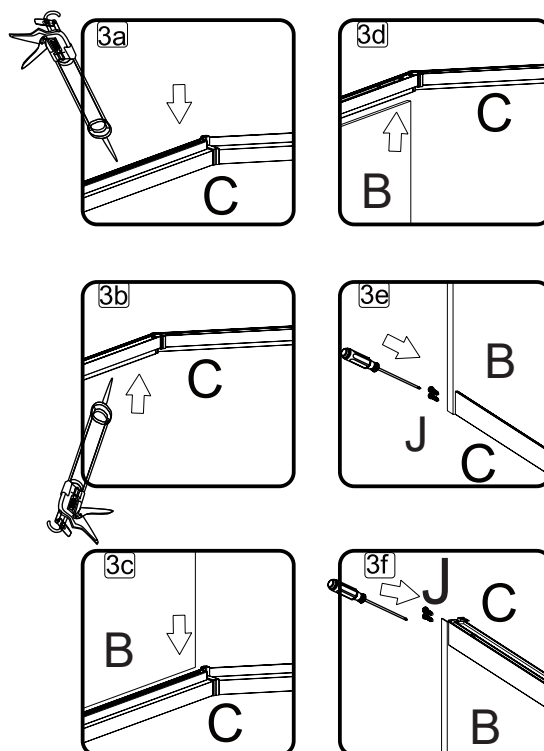
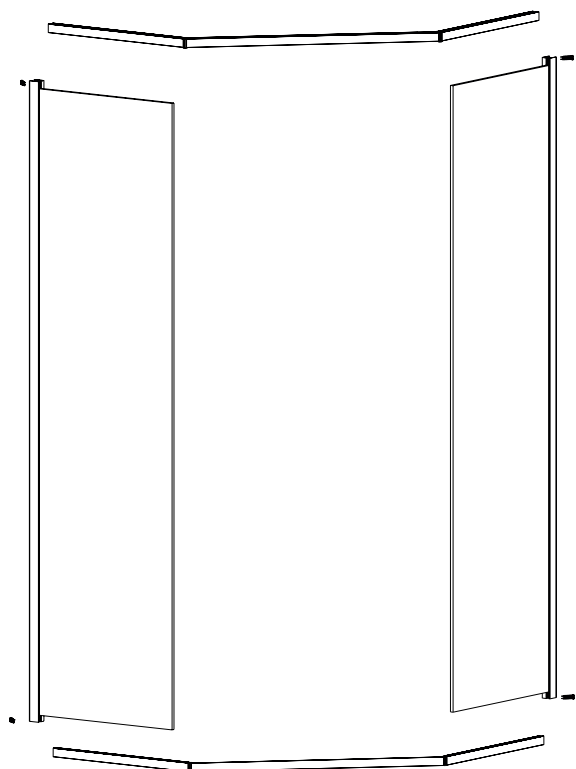

шаг 4

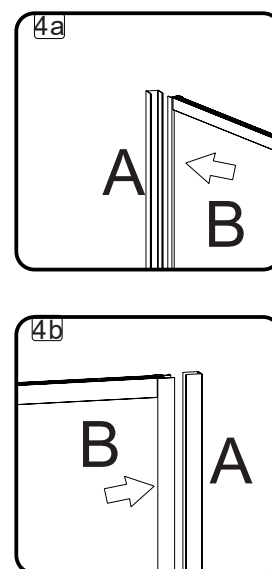
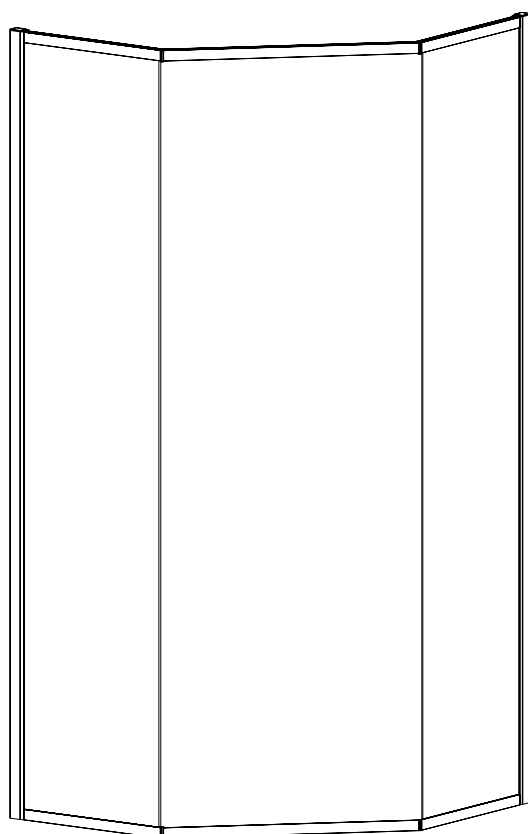

шаг 5

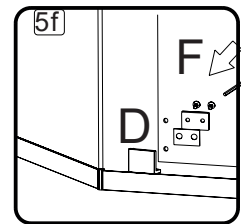
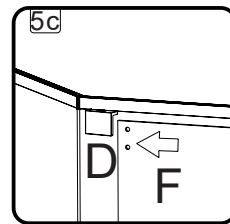
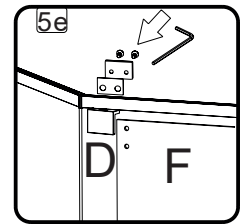
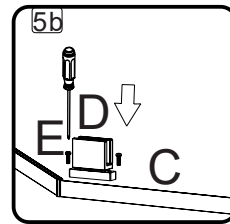
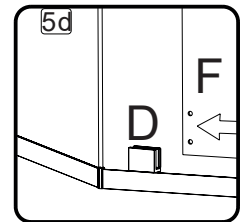
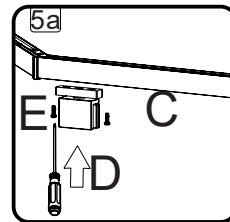
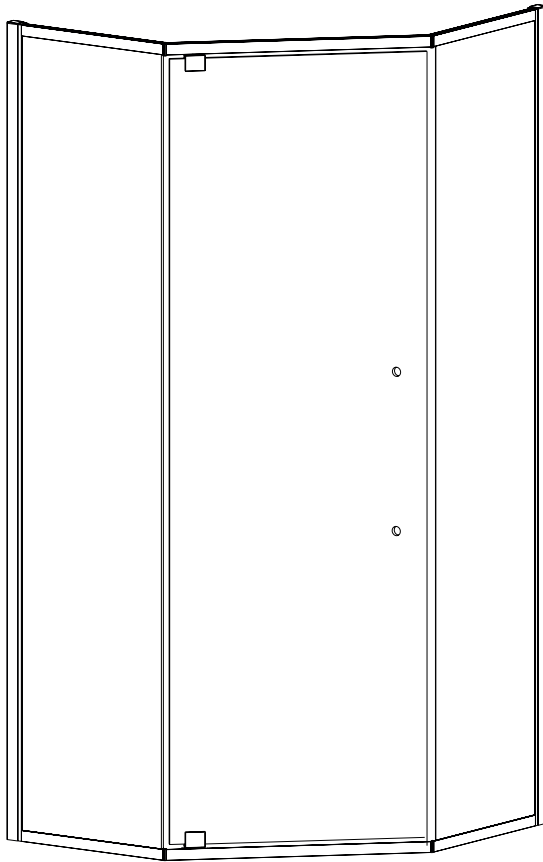

шаг 6

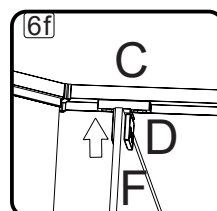
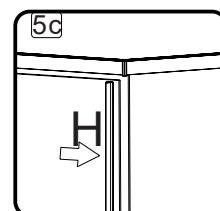
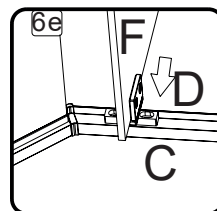
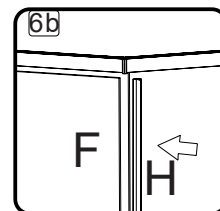
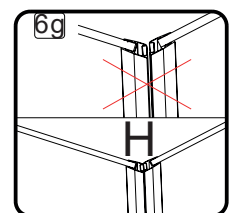
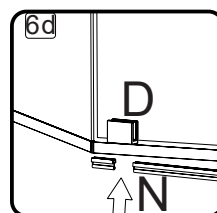
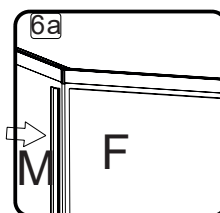
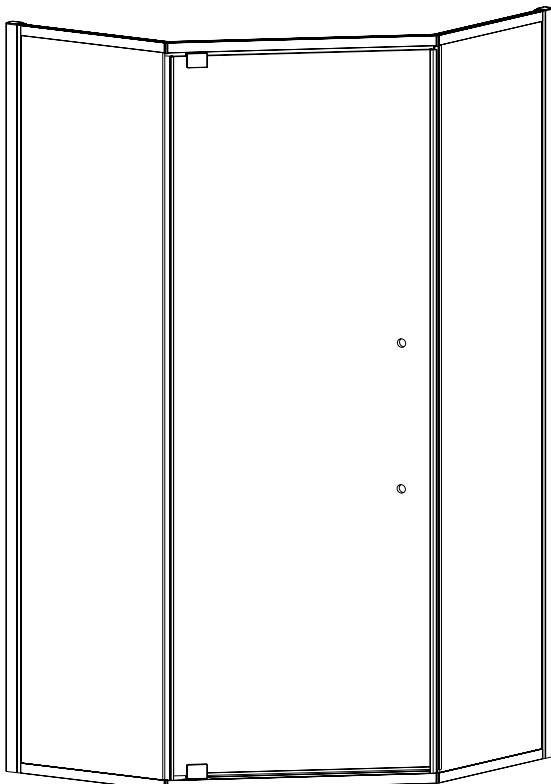

шаг 5

